

New products 2026

Price list



OPINION CIATTI®
FIRENZE

Novità / New products 2026



Original Ptolomeo
. wooden base .
pag. 2



Original Ptolomeo
. LED kit .
pag. 3



Yum
pag. 4

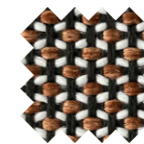

Outdoor fabrics for Yum
pag. 5



Mammamia Sled
pag. 6

Original Ptolomeo® wooden base



^{IT} Nuova finitura in rovere chiaro per la base di Original Ptolomeo nelle misure 160 e 215. Protettivo trasparente opaco. Piedini regolabili.

^{FR} Nouvelle finition en chêne clair pour la base de Original Ptolomeo dans les dimensions 160 et 215. Protection transparente mate. Pied réglables.

^{EN} New light oak finish for the base of Original Ptolomeo in sizes 160 and 215. Matte transparent protective coating. Adjustable feet.

^{DE} Neue Ausführung in heller Eiche für die Basis von Original Ptolomeo in den Größen 160 und 215. Matt transparenter Schutzlack. Verstellbare Füßchen.



Roberto

Prodotto registrato ® / Registered product ®



ADI COMPASSO D'ORO, 2004

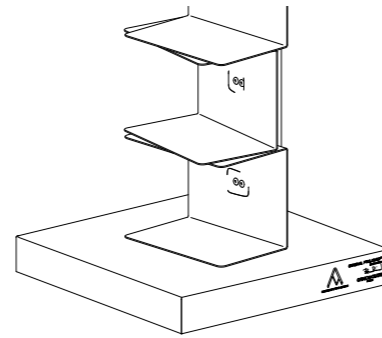
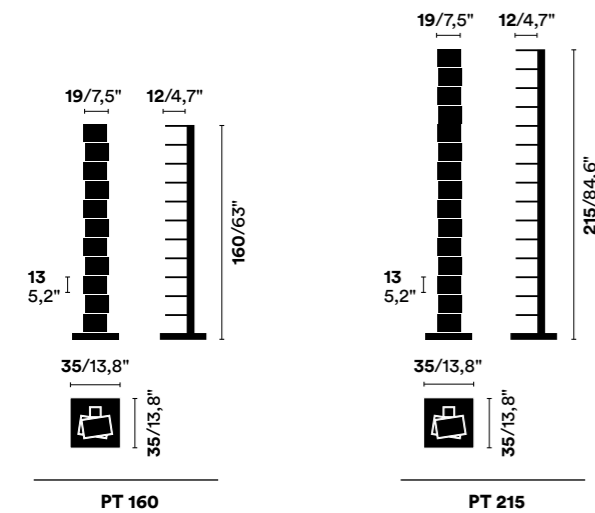

Base con firma del designer e premio Compasso d'Oro.
Base with the designer's signature and the Compasso d'Oro award.

	Bianco/Rovere White/Oak Blanc/Chêne Weiß/Eiche	Nero/Rovere Black/Oak Noir/Chêne Schwarz/Eiche	Corten/Rovere Corten/Oak Corten/Chêne Corten/Eiche	Inox/Rovere Stainless steel/Oak Acier inox/Chêne Edelstahl/Eiche
	WWD	BWD	CWD	XWD
PT 160	990,00	990,00	990,00	1.490,00
PT 215	1.050,00	1.050,00	1.050,00	1.690,00

Ptolomeo® LED kit



^{IT} Profilo in alluminio con strip LED integrata, dotato di striscia magnetica per il fissaggio alla colonna dei prodotti Ptolomeo, Ptolomeo Wall, Ptolomeo Art, Ptolomeo Vino e Ptolomeo Vino Wall.
Illuminazione LED diretta, 220 V - 2700°K. 1800 Lm/m per misure M e L, 1000 Lm/m per misura S. Cablaggio 2,5 m. Alimentatore elettronico con presa intercambiabile per uso indipendente a tensione costante VDT 24-48V. Completo di adattatore per EU e USA.

^{FR} Profilé en aluminium avec bande LED intégrée, doté d'une bande magnétique pour la fixation à la colonne des produits Ptolomeo, Ptolomeo Wall, Ptolomeo Art, Ptolomeo Vino et Ptolomeo Vino Wall.
Éclairage LED direct, 220 V - 2700 K. 1800 lm/m pour les dimensions M et L, 1000 lm/m pour la dimension S. Câblage 2,5 m. Alimentation électronique avec prise interchangeable pour utilisation indépendante à tension constante VDT 24-48 V. Complet avec adaptateur pour UE et USA.

^{EN} Aluminum profile with integrated LED strip, equipped with a magnetic strip for attachment to the column of Ptolomeo, Ptolomeo Wall, Ptolomeo Art, Ptolomeo Vino and Ptolomeo Vino Wall.
Direct LED lighting, 220 V - 2700°K. 1800 Lm/m for sizes M and L, 1000 Lm/m for size S. Wiring of 2,5 meters. Electronic interchangeable plug led driver. Constant voltage VDT 24-48 V. Provided with adapter for EU and USA.

^{DE} Aluminiumprofil mit integrierter LED-Leiste, ausgestattet mit einem Magnetstreifen zur Befestigung an der Säule der Produkte Ptolomeo, Ptolomeo Wall, Ptolomeo Art, Ptolomeo Vino und Ptolomeo Vino Wall.
Direkte LED-Beleuchtung, 220 V - 2700 K. 1800 lm/m für die Maße M und L, 1000 lm/m für das Maß S. Verkabelung 2,5 m. Elektronisches Netzteil mit austauschbarem Stecker für den unabhängigen Einsatz bei konstanter Spannung VDT 24-48 V. Inklusive Adapter für EU und USA.

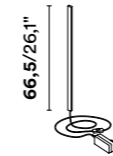

PTKITLEDS

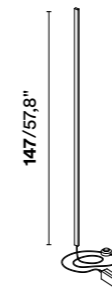

PTKITLEDM

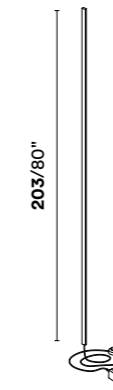

PTKITLEDL

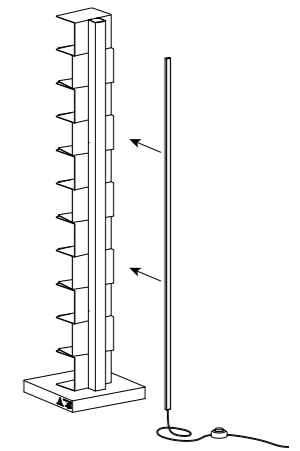

Esempio del fissaggio con magnete
Example of the magnetic attachment

PTKITLEDS	190,00
PTKITLEDM	330,00
PTKITLEDL	370,00

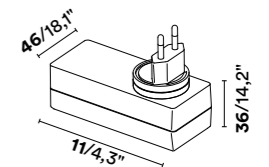

Ingombro del trasformatore (plug escluso).
LED driver dimensions (plug excluded)

Note

Non compatibile con colonna in finitura inox.
Not compatible with column in stainless steel finish.
Non compatible avec une colonne en finition inox.
Nicht kompatibel mit einer Säule in Edelstahl-Ausführung.

Yum Lapo Ciatti, 2026



IT Collezione di pouf imbottiti con schiumati a portanza differenziata, con rivestimento sfoderabile in tessuto o pelle, corredato da una pratica tasca. Se rivestiti in tessuto outdoor, sono dotati di una fodera impermeabile che rende il prodotto adatto all'uso all'aperto.

Tre misure: pouf singolo, pouf extra large, divanetto a due posti.
Rivestimenti: varie tipologie di tessuto e pelle. Tessuto cliente.

EN Collection of upholstered poufs with differentiated-density foams, featuring a removable cover in fabric or leather, equipped with a practical pocket. If upholstered in outdoor fabric, they include a waterproof lining that makes the product suitable for outdoor use.

Three sizes: single pouf, extra-large pouf, and two-seater sofa.
Upholsteries: various types of fabric and leather. Customer fabric.

FR Collection de poufs rembourrés avec des mousses à portance différenciée, avec un revêtement amovible en tissu ou en cuir, doté d'une poche pratique. S'ils sont revêtus de tissu outdoor, ils sont équipés d'une housse imperméable qui rend le produit adapté à une utilisation en extérieur.

Trois tailles : pouf simple, pouf extra large, canapé deux places.
Revêtements : divers types de tissus et de cuir. Tissu du client.

DE Kollektion gepolsterter Poufs mit Schaumstoffen mit differenzierter Tragfähigkeit, mit abnehmbarem Bezug aus Stoff oder Leder, ausgestattet mit einer praktischen Tasche. Wenn sie mit Outdoor-Stoff bezogen sind, verfügen sie über eine wasserdichte Innenhülle, die das Produkt für den Außenbereich geeignet macht. Erhältlich in drei Größen: Einsitzer-Sessel, Sessel Extra Large, und Zweisitzer-Sofa.

Bezüge: verschiedene Arten von Stoff und Leder. Kundenstoff.



Certificate TB117-2013 San Francisco
(con tessuti ignifughi / with fire resistant fabrics)

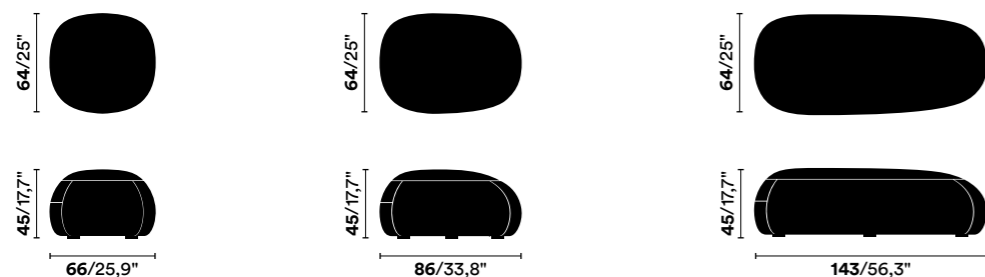

YUM 66

YUM 86

YUM 143

VERSIONE INDOOR / INDOOR VERSION / VERSION POUR L'INTÉRIEUR / INDOOR VERSIONEN

	A	B	C	D	X
YUM 66	1.399,00	1.620,00	1.650,00	1.761,00	1.215,00 (2,1 mt)
YUM 86	1.795,00	2.043,00	2.078,00	2.270,00	1.577,00 (2,4 mt)
YUM 143	2.572,00	2.983,00	3.037,00	3.126,00	2.213,00 (3,8 mt)

VERSIONE OUTDOOR / OUTDOOR VERSION / VERSION POUR L'EXTÉRIEUR / OUTDOOR VERSIONEN

	A OUTDOOR	B OUTDOOR	X OUTDOOR
YUM OUT 66	1.769,00	1.830,00	1.624,00 (2,1 mt)
YUM OUT 86	2.370,00	2.430,00	2.175,00 (2,4 mt)
YUM OUT 143	3.195,00	3.310,00	2.919,00 (3,8 mt)

CATEGORIA A OUTDOOR / CATEGORY A OUTDOOR

• NATURAL



COMPOSITION	CHARACTERISTICS	DURABILITY	LIGHT FASTNESS	RUB FASTNESS
100% PP solution dyed	Natural effect	40.000 Martindale	7/8	Dry 4/5, Wet 4/5
Bianco 01 White 01	Écru 03 Écru 03	Ocra 06 Ochre 06	Grigio chiaro 07 Light grey 07	Cobalto 15 Cobalt 15
	Verde 21 Green 21	Ruggine 35 Rust 35	Nero 15 Black 15	+ 9 colors A preventivo Upon request

CATEGORIA B OUTDOOR / CATEGORY B OUTDOOR

• SOFT



COMPOSITION	CHARACTERISTICS	DURABILITY	LIGHT FASTNESS	RUB FASTNESS
100% PP solution dyed	Bouclé effect	40.000 Martindale	7/8	Dry 4/5, Wet 4/5
Bianco 01 White 01	Écru 03 Écru 03	Ocra 06 Ochre 06	Grigio chiaro 07 Light grey 07	Cobalto 15 Cobalt 15
	Verde 21 Green 21	Ruggine 35 Rust 35	Nero 15 Black 15	+ 10 colors A preventivo Upon request

• REVERSE side A



COMPOSITION	CHARACTERISTICS	DURABILITY	LIGHT FASTNESS	RUB FASTNESS
20% recycled PP, 80% reclaimed PP	Eco-friendly	25.000 Martindale	7/8	Dry 4, Wet 4
Bianco 01 A White 01 A	Grigio chiaro 07 A Light grey 07 A	Écru 03 A Écru 03 A	Fango 23 A Mud 23 A	Verde scuro 22 A Dark green 22 A
	Verde 21 A Green 21 A	Ruggine 35 A Rust 35 A	Marrone 25 A Brown 25 A	+ 15 colors A preventivo Upon request

• REVERSE side B



COMPOSITION	CHARACTERISTICS	DURABILITY	LIGHT FASTNESS	RUB FASTNESS
20% recycled PP, 80% reclaimed PP	Eco-friendly	20.000 Martindale	7/8	Dry 4, Wet 4
Bianco 01 B White 01 B	Grigio chiaro 07 B Light grey 07 B	Écru 03 B Écru 03 B	Fango 23 B Mud 23 B	Verde scuro 22 B Dark green 22 B
	Verde 21 B Green 21 B	Ruggine 35 B Rust 35 B	Marrone 25 B Brown 25 B	+ 15 colors A preventivo Upon request

Note

Tessuti utilizzabili anche in indoor; si applicano i prezzi delle categorie indoor.
Fabrics also suitable for indoor use; indoor category prices apply.
Tissus également adaptés à un usage intérieur; s'appliquent les catégories de prix indoor.
Stoffe auch für den Innenbereich geeignet; es gelten die Preise der Innenkategorien.

Mammamia Sled Marcello Ziliani, 2019-2026



IT Sedia con scocca in pressofusione d'alluminio e struttura a slitta in acciaio con braccioli, impilabile. Per uso indoor/outdoor.

Finiture opache: malta ecologica (Corkcrete) nei colori beige, grigio o tortora; alluminio naturale (Raw) con trasparente protettivo opaco; colori RAL Classic.

Finiture lucide: alluminio specchio, foglia oro, foglia argento, foglia rame.

Finiture versioni imbottite (non sfoderabili, non impilabili): rivestimento in varie tipologie di tessuto, pelle o tessuto cliente, con struttura verniciata in colore RAL coordinato con il tessuto.

Finitura opzionale struttura: galvanica cromo.

Accessori: cuscino in feltro.

EN Chair with frame in die-cast aluminum and sled structure in steel with armrests, stackable. For indoor/outdoor use.

Matt finishes: textured coating with concrete or bronze effect. Ecological mortar (Corkcrete) in beige, grey or taupe colors. Raw finish (natural aluminum) with clear matt protective coating. RAL Classic colors.

Glossy finishes: aluminium with mirror finish, gold leaf, silver leaf, copper leaf.

Finishes for upholstered versions (non-stackable, non-removable cover): various types of leather and fabric (including customer fabric) with structure painted in RAL color coordinated with the fabric.

Optional structure finish: polished chrome.

Accessories: felt cushion.



USO OUTDOOR, ECCETTO VERSIONI IN FOGLIA E IMBOTTITE
OUTDOOR USE, EXCEPT LEAF-FINISH AND UPHOLSTERED VERSIONS
USAGE OUTDOOR, SAUF VERSIONS EN FEUILLE ET REMBOURRÉES
AUSSENBEREICH, AUSGENOMMEN FOLIE UND GEPOLSTERTE VERSIONEN

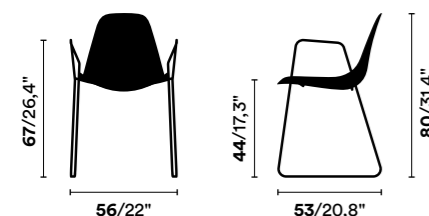

MAMMASLB

Note

L'applicazione delle finiture in foglia e Corkcrete è artigianale, ogni pezzo è quindi unico con variazioni di finitura.

The leaves and Corkcrete finishes are hand-crafted, thus making every item unique and featuring finishes variations.

Les finitions feuille et Corkcrete sont appliquées artisanalement, chaque pièce est unique et présente des particularités.

Die Ausführungen mit strukturiertem Corkcrete und mit Folie werden von Hand aufgetragen. Jedes Stück ist einmalig und hat seine Besonderheiten.

Finitura Raw: ogni pezzo è unico con variazioni di finitura.

Raw finish: every item is unique and features finishes variations.

Finition Raw: chaque pièce est unique et présente des particularités.

Raw Ausführung: Jedes Stück ist einmalig und hat seine Besonderheiten.

FR Chaise avec coque moulée sous pression en aluminium et structure en forme de traîneau en acier avec accoudoirs. Empilable. Pour usage à l'intérieur et à l'extérieur.

Finitions mates : vernissages texturés effet ciment ou bronze. Mortier écologique (Corkcrete) dans les couleurs beige, gris ou taupe. Finition aluminium naturel (Raw) avec revêtement protecteur transparent mat. Couleur RAL Classic.

Finitions brillantes : aluminium miroir, feuille d'or, feuille d'argent, feuille de cuivre.

Finitions versions rembourrées (non déhoussables, non empilables) : différents types de tissus et de cuir (y compris le tissu client) avec structure peinte dans la couleur RAL coordonnée au tissu.

Finition optionnelle de la structure: chromée.

Accessoires : coussin en feutre.

DE Stuhl mit Sitzschale aus Aluminium-Pressguß und Kufengestell aus Stahl, mit Armlehnen. Stapelbar. Für Innen- und Außenbereich geeignet.

Matte Ausführungen: strukturierter Oberflächeneffekt in Zement oder Bronze. Ökologischer Spezialmörtel (Corkcrete) in Beige, Grau oder Taubengrau.

Aluminium natur (Raw) mit transparentem mattem Schutzlack. RAL Classic Farbe.

Glänzende Ausführungen: Aluminium verspiegelt, Goldfolie, Silberfolie, Kupferfolie.

Bezüge gepolsterte Versionen (nicht abziehbar, nicht stapelbar): verschiedene Stoffe und Leder. Kundenstoff. Gestell lackiert in RAL-Farbe angepasst mit dem Stoff.

Optionale Ausführung der Struktur: Chrom

Zubehör: Kissen aus Filz.

Certificazione / Certification / Certification / Zertifizierung

UNI EN 16139:2013







Certificate TB117-2013 San Francisco
(con tessuti ignifughi / with fire resistant fabrics)

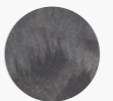

Impilabilità fino a 4 sedie
Stackable up to 4 chairs
Empilable jusqu'à 4 chaises
Stapelbar bis zu 4 Stühlen

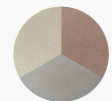
IMPILABILE / STACKABLE / EMPILABLE / STAPELBAR

	 RAL/RAL	 Raw/RAL	 Alluminio specchio/cromo Aluminum mirror/chrome Aluminium verspiegelt/Chrome	 Corkcrete/RAL (beige/grigio/tortora) Corkcrete/RAL (beige/gris/taupe) Corkcrete/RAL (Beige/Grau/Taubengrau)	 Foglia (oro/argento/rame) Leaf (gold/silver/copper) Feuille (or/argent/cuivre) Folie (Gold/Silber/Kupfer)
	RAL	RAW	XX	CKB / CKG / CKT	LG / LS / LC
MAMMASLB	655,00	728,00	1.020,00	995,00	1.070,00

* Finitura non adatta all'uso outdoor / Finish non suitable for outdoor use / Finition non adaptée à un usage extérieur / Ausführung nicht für den Außenbereich geeignet







Struttura cromo a preventivo / Chrome structure upon request / Structure chromé sur devis / Gestell Chrom auf Anfrage



Non impilabile
Non-stackable
Non empilable
Nicht Stapelbar

NON IMPILABILE, IMBOTTITA / NON-STACKABLE, UPHOLSTERED / NON IMPILABLE, REMBOURRÉE / NICHT STAPELBAR, GEPOLSTERTE

	 A*	 B	 C	 D	 X
MAMMASLB	945,00	987,00	1.064,00	1.185,00	790,00 (1,1 mt)

* Ad eccezione di nabuk ecologico / Except for ecological nubuck / Sauf pour nubuck écologique / Außer Öko-Nubukleder

Finiture struttura / Finishes structure / Finitions de la structure / Ausführungen Gestell





Struttura verniciata in colore RAL coordinato con il tessuto / Structure painted in RAL color coordinated with the fabric
Structure peinte dans la couleur RAL coordonnée au tissu / Gestell lackiert in RAL-Farbe angepasst mit dem Stoff



Struttura cromo a preventivo / Chrome structure upon request / Structure chromé sur devis / Gestell Chrom auf Anfrage

Accessories and extras

	MAMMA CUSHION Cuscino sagomato in feltro antiscivolo, colore grigio. Shaped non-slip cushion in felt, grey color. Coussin gris en feutre antidérapant. Geformtes rutschfestes Kissen aus grauem Filz.	57,00
	MAMMAONE Supplemento imballo singolo / surcharge for single package supplément pour emballage single / Zuschlag für Einzelverpackung	37,00

CONDIZIONI GENERALI DI VENDITA

ORDINI

Le condizioni di vendita qui indicate si ritengono integralmente accettate dall'acquirente con il conferimento dell'ordine.

Gli ordini ricevuti impegnano OPINION CIATTI srl solamente dopo conferma scritta per accettazione da parte di OPINION CIATTI srl stessa. Ogni eventuale disaccordo sulle condizioni della nostra conferma d'ordine deve essere segnalato entro 3 giorni dalla data di ricevimento; in mancanza, la conferma si ritiene definitiva.

Eventuali annullamenti o modifiche degli ordini devono pervenirci entro 3 giorni dalla data dell'ordine e hanno validità solo se accettati per iscritto dall'Azienda, la quale potrà chiedere un rimborso per le spese causate dall'annullamento. OPINION CIATTI srl ha la facoltà di sospendere le forniture qualora le condizioni economiche dell'acquirente fossero tali da porre in evidente pericolo il conseguimento del pagamento.

Prezzi/pagamenti

Il presente listino annulla e sostituisce il precedente e può essere variato in qualsiasi momento. I prezzi sono espressi in **Euro IVA esclusa**.

Le modalità di pagamento sono precisate sulla conferma d'ordine, il pagamento si intende a far data della nostra fattura. In caso di ritardo nel pagamento rispetto alla scadenza concordata, sarà stornato l'eventuale sconto cassa concesso e saranno applicati gli interessi di mora al tasso in vigore in Italia.

PRODOTTI

OPINION CIATTI srl è un'azienda in cui tutto il processo è regolato da norme ben precise e da rigorosi controlli. Ogni nostro prodotto è stato costruito con materiali accuratamente selezionati, con un alto standard qualitativo. MADE IN ITALY.

Modifiche

OPINION CIATTI srl si riserva di apportare ai propri prodotti, senza alcun preavviso, eventuali cambiamenti o modifiche ritenute necessarie per il miglioramento delle caratteristiche tecniche o per esigenze commerciali.

I disegni sul listino non definiscono i dettagli del prodotto; le misure sono indicative e possono subire variazioni.

Garanzia

OPINION CIATTI srl presta la garanzia di due anni nei termini prescritti dagli art.128 e seguenti del D.Lgs. 206/2005 (c.d. Codice del Consumo). Usi impropri del prodotto fanno automaticamente decadere la garanzia.

Prodotti speciali

OPINION CIATTI srl si riserva la facoltà di accettare, a propria discrezione, ordini con misure o finiture non previste dal listino per i quali verrà fornito di volta in volta il prezzo. L'accettazione dell'Azienda sarà subordinata a valutazioni di carattere tecnico, così come a valutazioni di carattere commerciale.

Reclami - resi

Eventuali reclami, di qualunque genere essi siano, si accettano solo se comunicati per iscritto **entro 7 gg** dal ricevimento della merce. Reclami relativi a difetti di qualità, dopo essere documentati, daranno origine alla riparazione o restituzione del prodotto da noi giudicato difettoso.

L'accettazione del reso autorizzato da OPINION CIATTI non presuppone la sostituzione della merce. Il cliente è responsabile per il corretto imballaggio del prodotto reso. In caso di ulteriori danni arrecati al prodotto per insufficiente protezione dello stesso, l'Azienda si riserva di addebitare al cliente le spese di riparazione.

OPINION CIATTI srl respingerà al mittente i resi non autorizzati.

Tolleranze

I colori indicati nel nostro campionario (verniciature, tessuti, materiali vari) devono intendersi puramente indicativi, non essendo tecnicamente possibile garantire la loro invariabilità nel tempo. L'esposizione diretta dei prodotti alla luce solare può alterarne i colori. In caso di completamento ed abbinamento tra diversi prodotti, non si garantisce l'uniformità di colore.

I tessuti e le pelli possono variare di tonalità da una partita all'altra, pertanto l'Azienda non si assume responsabilità. Per il lavaggio dei tessuti si consiglia di attenersi alle indicazioni fornite in questo listino. È buona norma tuttavia ricorrere a personale specializzato o al lavaggio a secco. I rivestimenti vengono confezionati, a richiesta, con tessuto del cliente, senza nessuna responsabilità da parte dell'Azienda per quanto riguarda il risultato formale, la durata del tessuto e la costanza dei colori.

Le lavorazioni artigianali come la stropicciatura dell'alluminio, l'applicazione della foglia oro o argento e del cemento rendono ogni pezzo unico con variazioni di finitura.

TRASPORTI

Termini di consegna

Qualora non concordato diversamente, l'Azienda consegna il prodotto di serie entro 60 giorni circa dalla conferma dell'ordine da parte del Cliente. Le lavorazioni speciali richiedono 90 giorni circa dalla conferma dell'ordine da parte del Cliente.

La consegna si intende valida ad ogni effetto, anche se fatta a mezzo spedizioniere o vettore.

Spetta al destinatario verificare il peso della merce, il numero dei colli e lo stato dell'imballaggio prima del ritiro e comunicare le dovute riserve al vettore, essendo quest'ultimo responsabile di mancanze o avarie ed inviare copia all'Azienda entro 24 ore. Oltre il termine non potranno in alcun modo e per nessuna ragione essere imputate all'Azienda. I termini di consegna esposti nelle conferme d'ordine hanno unicamente valore indicativo.

Le richieste di consegne tassative devono essere concordate con l'Azienda. Non si accettano penalità nè responsabilità per ritardata consegna.

Spese di trasporto

In alcuni Paesi europei (A-B-CH-D-E-F-I-L-NL-P), per ordini superiori ad un ammontare netto minimo, le spese di trasporto all'indirizzo del rivenditore sono incluse. Si prega di contattare OPINION CIATTI srl in caso di esigenze speciali.

I nostri imballi sono testati per spedizioni via terra e via mare. Nel caso in cui si richieda un imballo fuori standard in cassa di legno sarà applicato un sovrapprezzo a preventivo.

Reclami - restituzioni

I reclami per danneggiamenti avvenuti durante il trasporto, andranno direttamente contestati al Corriere sulla lettera di vettura e comunicati per l'autorizzazione al rientro in OPINION CIATTI srl.

Foro competente

Per qualunque controversia nata da nostre forniture sarà competente il Foro di Firenze, Italia.

GENERAL SALES CONDITIONS

ORDERS

Sales conditions indicated below are considered fully accepted by the customer with the order submission.

The orders received commit OPINION CIATTI srl only after a written confirmation by OPINION CIATTI srl itself. Every disagreement on the sales conditions of our order confirmation has to be indicated within 3 days from the date of receipt, otherwise the confirmation is considered as definitive.

Possible cancellations or changes to the orders are accepted up to 3 days from the date of the order and are valid only if accepted in writing by the Company. Costs caused by the cancellation of an order may be charged.

OPINION CIATTI srl is entitled to suspend deliveries when the financial conditions of the customers are such that the receipt of payment is clearly at risk.

Prices/payments

The present price list cancels and replaces all previous ones and can be changed at any time. The prices are expressed in **Euro VAT excluded**.

Methods and terms of payment are indicated in the order confirmation.

In the event of late payment on the agreed date, settlement discounts will be cancelled and the interest on arrears will be charged at the current Italian commercial rate.

PRODUCTS

Opinion Ciatti srl is a company where all the production process is based on very precise rules and rigorous checks. Every product is made with very carefully selected materials and a high quality standard: 100% MADE IN ITALY.

Changes

OPINION CIATTI srl reserve the right to make possible changes to models if necessary for improving technical characteristics or for commercial reasons, without any prior notice. The drawings included in the price list do not define the details of the product and the sizes shown should be considered indicative.

Warranty

A two-year warranty is granted by Opinion Ciatti srl as per the Article 128 and following the Decree Law 206/2005 (Consumer Code). Improper use of the product automatically annuls the warranty.

Special products

Opinion Ciatti srl reserve the right to accept, at its own discretion, orders with sizes and finishes not included in the price list. The relevant prices will be notified on each occasion. Acceptance by the Company is submitted to evaluations of technical and commercial reasons

Complaints – returns

Any complaint of whatsoever type is accepted only if notified in writing **within 7 days** from the receipt of the goods.

Acceptance of the returned goods by OPINION CIATTI srl do not presuppose substitution of the goods. The Customer is responsible for adequate packaging of the product returned. Further damage to the product caused by inadequate protection of the same will authorize the Company to charge the customer the repair costs.

Tolerances

Wood, paints, fabrics and other materials samples should be considered indicative as small variations in colour or shade may occur in different production batch. Products exposed to direct sunlight may be subject to fading. Conformity of products to samples or subsequent supplies must be evaluated according to normal technical tolerances of which the purchaser must be aware.

The fabrics and the leather may vary in tone from one batch to the other, therefore the Company declines all responsibility. Customers should meticulously follow washing instructions. In any case, it is always better to entrust washing to qualified professionals or dry cleaners. On request we upholster our products with the customer's own fabric. The Company, in any case, won't be responsible for the formal result, the fabric's wear and the constancy of colours.

The hand-crafted process like the aluminium wrinkling, the application of the silver or gold leaf and of the concrete make every piece unique with finishes variations.

DELIVERY

Delivery terms

Unless otherwise agreed, the Company shall deliver the standard products within approximately 60 days from the date of the order confirmation by the customer. Special workmanships require approximately 90 days from the date of the order confirmation by the customer.

Delivery is always valid, even if carried out by a forwarding agent or other third party.

It is responsibility of the customer to verify the weight of the goods, the number of packages and the packaging condition before accepting the goods and point out all the complaints to the forwarder, as the forwarder is responsible for missed or damaged goods. A copy of the complaint notification must be sent to the Company within 24 hours. After this term the supplier cannot be accused in any way or for any reason for the complaint.

The terms of delivery on the order confirmation are non-binding. Requests for set date deliveries must be agreed with the Company. Penalties or eventual responsibility for delays will not be accepted.

Delivery costs

In some European countries (A-B-CH-D-E-F-I-L-NL-P), above a minimum net amount, the delivery cost to retailer's address is included. Special requirements have to be discussed with the Company.

Our packages are tested for deliveries overland and by sea. In case a special packaging in wooden crate is required, an extra charge upon request will be applied.

Complaints – returns

Complains for the damages occurring during the transportation must be indicated on the transport document for the carrier and communicated to OPINION CIATTI srl for return authorisation.

Court of justice

For any dispute, the place of jurisdiction is Florence, Italy.

Opinion Ciatti Srl

via di Prato, 80
50041 Calenzano, Firenze - Italia
T.: + 39 055 88 70 91
F.: + 39 055 88 70 92 37
info@opinionciatti.com

www.opinionciatti.com

